



---

## Equipamientos

La ergonomía, es la palabra clave en la distribución moderna de una cocina. Kesseböhmer, lleva toda una vida liderando los conceptos de la funcionalidad, calidad y percepción de marca de nivel que ayuda a prestigiar las cocinas más innovadoras.

Aplicaciones como el afamado rinconero Lemans o la columna Tandem, son solo algunos ejemplos de cómo el almacenamiento, no solo puede llegar a ser funcional, sino además bello.

En DB GROUP, siempre hemos apostado por las mejores marcas e Inoxa es otra de ellas.

El éxito de esta firma italiana de dilatada trayectoria, se podría definir como competitividad.

Amplísimas gamas de herrajes de todo tipo de medidas, opciones y soluciones, que garantizan el perfecto funcionamiento de un extraíble.

Hacemos del Interiorismo nuestra pasión. Convertimos tus cocinas en inteligentes.





KESSEBÖHMER



# ARENA pure // Trayectoria de éxito





## Zertifikat

Prüfungsnorm **ISO 9001:2015**  
Zertifikat-Registrier-Nr. **01 100 1400579**

Unternehmen: **Kesseböhmer Holding KG**  
Mündener Str. 208  
49152 Bad Essen  
Deutschland  
mit den Standorten gemäß Anlage



Geltungsbereich: Entwicklung, Herstellung und Vertrieb von Beschlägen, Tischgestell- und Entertaimentssystemen für die Möbelindustrie sowie Caravanmöbeln, Wanddisplays, Automobilteilen und Industrieprodukten

Durch ein Audit wurde der Nachweis erbracht, dass die Forderungen der ISO 9001:2015 erfüllt sind.

Gültigkeit: Dieses Zertifikat ist gültig vom 10.09.2021 bis 09.09.2024.  
Erstzertifizierung 1995

27.09.2021

*L. G. G.*  
TÜV Rheinland Cert GmbH  
Am Grauen Stein • 51105 Köln

www.tuv.com



## Anlage zum Zertifikat

Prüfungsnorm **ISO 9001:2015**  
Zertifikat-Registrier-Nr. **01 100 1400579**

Nr.	Standort	Geltungsbereich
.01	c/o <b>Kesseböhmer Holding KG</b> Mündener Str. 208 49152 Bad Essen Deutschland	Entwicklung, Herstellung und Vertrieb von Beschlägen, Tischgestell- und Entertaimentssystemen für die Möbelindustrie sowie Caravanmöbeln, Wanddisplays, Automobilteilen und Industrieprodukten
.02	c/o <b>Kesseböhmer GmbH</b> Mündener Str. 208 49152 Bad Essen Deutschland	Vertrieb von Beschlägen, Tischgestell- und Entertaimentssystemen für die Möbelindustrie sowie Caravanmöbeln und Industrieprodukten
.03	c/o <b>Kesseböhmer Beschlagssysteme GmbH &amp; Co. KG</b> Mündener Str. 208 49152 Bad Essen Deutschland	Entwicklung und Herstellung von Beschlägen, Automobilteilen und Industrieprodukten
.08	c/o <b>Kesseböhmer Automotive GmbH</b> Mündener Str. 208 49152 Bad Essen Deutschland	Vertrieb von Automobilteilen und Industrieprodukten

27.09.2021

*L. G. G.*  
TÜV Rheinland Cert GmbH  
Am Grauen Stein • 51105 Köln

Seite 1 von 1

www.tuv.com



# ARENA pure // Garantía

Todos los productos ARENA PURE, están fabricados con la prestigiosa tecnología Arena, que garantiza con respecto a otras opciones del mercado, una mayor capacidad de carga y una perfecta estanqueidad, conferida por su contrastada unión entre perfil metálico y suelo de madera.

**El concepto original Arena, exclusivo y patentado.**



# ARENA pure // Características de la serie

- Para los cestos cuadrados se emplea acero perfilado de alta resistencia con base de madera. Para los cestos con formas no cuadradas, se emplea perfil de aluminio en combinación con la base de madera para la obtención de un óptimo acabado. (exclusivo para toda la serie Pure).
- Revestimiento Arena antideslizante (exclusivo para toda la serie Pure).
- Alta durabilidad y resistencia obtenida mediante test de laboratorio que consigue cestos duraderos, de calidad y sostenibles.





VISIBILIDAD TOTAL



MÁXIMO APROVECHAMIENTO



ÁNGULO DE APERTURA 85°



MOVIMIENTO EMOCIONAL



CAPACIDAD DE CARGA  
25 Kg. por Bandeja

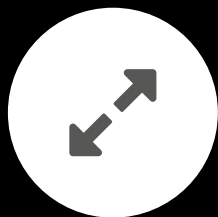

REGULABLE EN ALTURA



Con una capacidad de carga de 25 Kg. el módulo LeMans es inmensamente robusto.

Incluso con una carga máxima, el deslizamiento y amortiguación del LeMans es suave y silencioso.



LeMans II

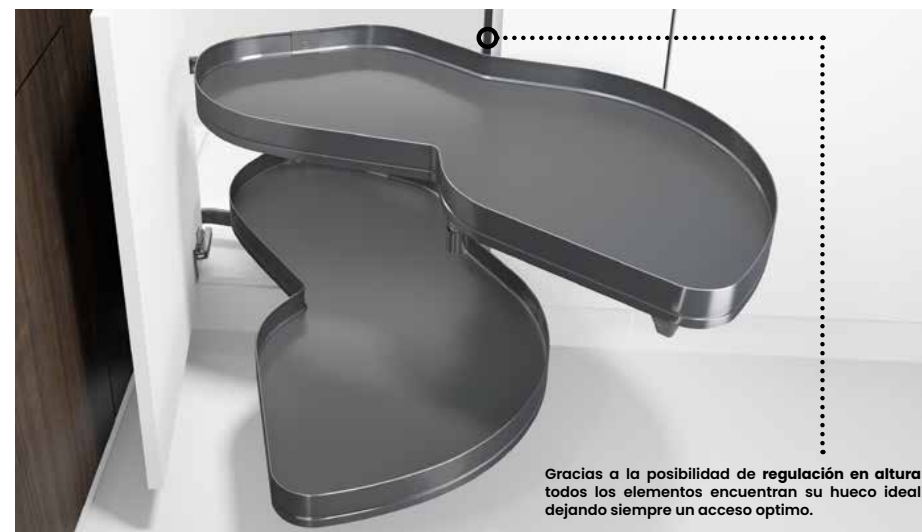

Gracias a la posibilidad de regulación en altura todos los elementos encuentran su hueco ideal dejando siempre un acceso óptimo.



KESSEBÖHMER



# LeMans II

Ejemplo. Apertura a derechas



## LEMANS II PURE

NOVEDAD  
L'abgroup



Código	Descripción	Ancho Puerta	Alto	Acabado	Embalaje
0501202	Set 2 Bandejas Derecha + Frenos	450	---	Pure/Antracita/Antracita	1
0501302	Set 2 Bandejas Izquierda + Frenos	450	---	Pure/Antracita/Antracita	1
0501402	Set 2 Bandejas Derecha + Frenos	500	---	Pure/Antracita/Antracita	1
0501502	Set 2 Bandejas Izquierda + Frenos	500	---	Pure/Antracita/Antracita	1
0501602	Set 2 Bandejas Derecha + Frenos	600	---	Pure/Antracita/Antracita	1
0501702	Set 2 Bandejas Izquierda + Frenos	600	---	Pure/Antracita/Antracita	1
0402407	Eje	---	600 - 750	Antracita	1
0402507	Eje	---	720 - 900	Antracita	1
0402607	Eje	---	≥1250	Antracita	1

**i** El Set 2 Bandejas, incluye los dos frenos.  
 Válido para diferentes alturas de mueble en función del eje que se instale.  
 Bandejas independientes regulables en altura que permiten un mejor aprovechamiento del espacio interior.  
 Capacidad de carga por bandeja 25 Kg.





## TORNO GIRATORIO 3/4 PURE

NOVEDAD  
Hologroup



Código	Descripción	Alto	Acabado	Embalaje
0501802	Set 2 Bandejas Ø 82	630 - 680	Pure/Antracita/Antracita	1
0450791	Eje	685 - 735	Cromo	1
0450891	Eje	742 - 832	Cromo	1
0450991	Eje	839 - 889	Cromo	1

**i** Válido para diferentes alturas de mueble en función del eje que se instale.  
Bandejas independientes regulables en altura que permiten un mejor aprovechamiento del espacio interior.  
Capacidad de carga por bandeja 25 Kg.



## TANDEM II PURE

NOVEDAD  
Hologroup



Código	Descripción	Ancho Módulo	Alto	Acabado	Embalaje
0501902	Kit set Tandem II	450	1700	Pure/Antracita/Antracita	1
0502002	Kit set Tandem II	600	1700	Pure/Antracita/Antracita	1
0200602	Expulsador Type 3	---	---	Antracita	1
0200402	Base Type 2-3	---	---	Antracita	1

**i** Reversible.  
Cestas regulables en altura, tanto las cestas interiores como las que van en la puerta.

Opcional

Expulsador TYPE 3

Base TYPE 2-3





## TANDEM side PURE (columna)

NOVEDAD Lidogroup



Código	Descripción	Ancho Módulo	Alto	Acabado	Embalaje
0403907	Bastidor puerta	450	1700	Antracita	1
0404007	Bastidor puerta	600	1700	Antracita	1
0502102	Set 3 cestas Tandem Side	450	---	Pure/Antracita/Antracita	1
0502202	Set 3 cestas Tandem Side	600	---	Pure/Antracita/Antracita	1
0200502	Expulsador Type 2	---	---	Antracita	1
0200402	Base Type 2-3	---	---	Antracita	1

**i** Reversible.  
La instalación del Tandem Side, requiere un espacio frontal libre de 175 mm. Las cestas del Tandem Side, se pueden posicionar a diferentes alturas. Para el Bastidor puerta de 1700 mm. se deberá montar con 2 Set 3 Cestas Tandem Side.



## TANDEM side PURE (mueble bajo)

NOVEDAD Lidogroup



Código	Descripción	Ancho Módulo	Alto	Acabado	Embalaje
0403707	Bastidor puerta	450	600	Antracita	1
0403807	Bastidor puerta	600	600	Antracita	1
0502102	Set 3 cestas Tandem Side	450	---	Pure/Antracita/Antracita	1
0502202	Set 3 cestas Tandem Side	600	---	Pure/Antracita/Antracita	1
0200502	Expulsador Type 2	---	---	Antracita	1
0200402	Base Type 2-3	---	---	Antracita	1

**i** Reversible.  
La instalación del Tandem Side, requiere un espacio frontal libre de 175 mm. Las cestas del Tandem Side, se pueden posicionar a diferentes alturas. Para el Bastidor puerta de 600 mm. se deberá montar con 1 Set 3 Cestas Tandem Side.





## DISPENSA 90 PURE

NOVEDAD  
Hologroup

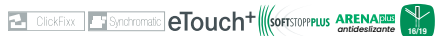

Código	Descripción	Ancho Módulo	Alto Módulo	Acabado	Embalaje
0500702	Estructura + Fijaciones	300	1900 - 2300	Antracita	1
0500802	Estructura + Fijaciones	400	1900 - 2300	Antracita	1
0460391	Pletina Unión Frente	---	---	Gris	1
0501102	Guía Dispensa 90 - 100 kg. PRO	---	---	Antracita	1
<b>0502302</b>	Set Juego 2 Bandejas	300	---	Pure/Antracita/Antracita	1
<b>0502402</b>	Set Juego 2 Bandejas	400	---	Pure/Antracita/Antracita	1
<b>0502502</b>	Set Youboxx 5	---	---	Antracita	1
0510120	eTOUCH+ Electrónico	---	---	Gris	1

**i** La Dispensa 90° admite instalación solo con bandejas o con bandejas y Set Youboxx. Las bandejas de la Dispensa 90° son las mismas que las de Dispensa junior III.



## DISPENSA junior III PURE

NOVEDAD  
Hologroup



Código	Descripción	Ancho Módulo	Alto	Acabado	Embalaje
0502602	Bastidor Dispensa Junior III	300	631	Antracita	1
0502702	Bastidor Dispensa Junior III	400	631	Antracita	1
<b>0502302</b>	Set Juego 2 Bandejas	300	---	Pure/Antracita/Antracita	1
<b>0502402</b>	Set Juego 2 Bandejas	400	---	Pure/Antracita/Antracita	1
<b>0502502</b>	Set Youboxx 5	---	---	Antracita	1

**i** La Dispensa junior III admite instalación solo con bandejas o con bandejas y Set Youboxx. Las bandejas de la Dispensa junior III son las mismas que las de Dispensa 90°.







KESSEBÖHMER



## TURNMOTION II PURE

NOVEDAD  
Ulabgroup

ARENA 2020  
antideslizante 10/19

Código	Descripción	Ancho Módulo	Alto	Acabado	Embalaje
0502802	TurnMotion II	600	383	Pure/Antracita/Antracita	1

**i** Este artículo permite poder acceder a toda la superficie de la bandeja desde el frente y sin esfuerzos, a diferencia de la incomodidad que supone la balda fija. Especialmente indicado, para módulos columna superiores. Regulable en altura.





## K-LINE 15 3DX

NOVEDAD  
Hologroup



Código	Descripción	Ancho Módulo	Alto	Acabado	Embalaje
0502902	Extraíble K-Line 15 3DX	150	525	Antracita	1
0503302	Separador Extraíble K-Line	---	---	Antracita	1
0200502	Expulsador Type 2	---	---	Antracita	1
0200402	Base Type 2-3	---	---	Antracita	1

**i** Para una optimización logística, este herraje se suministrará desmontado. Junto con los cestos se incluye un kit de planchas protectoras para el suelo del cesto para reducir la posible sonoridad. Este artículo va equipado con guía XP extracción total **GRASS**

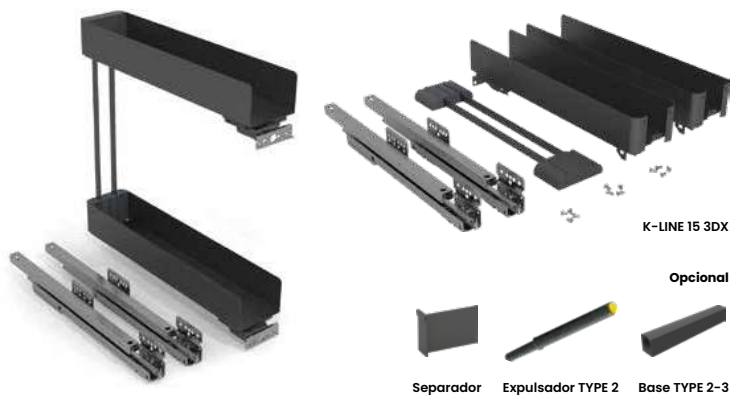

Regulación manual sin herramientas



Instrucciones K-line 15 3DX



## K-LINE BASE

NOVEDAD  
Hologroup



Código	Descripción	Ancho Módulo	Alto	Acabado	Embalaje
0503002	Extraíble K-Line base	200	523	Antracita	1
0503102	Extraíble K-Line base	300	523	Antracita	1
0503202	Extraíble K-Line base	400	523	Antracita	1
0503302	Separador Extraíble K-Line	---	---	Antracita	1
0200502	Expulsador Type 2	---	---	Antracita	1
0200402	Base Type 2-3	---	---	Antracita	1

**i** Para una optimización logística, estos herrajes se suministrarán desmontados. Junto con los cestos se incluye un kit de planchas protectoras para el suelo del cesto para reducir la posible sonoridad.

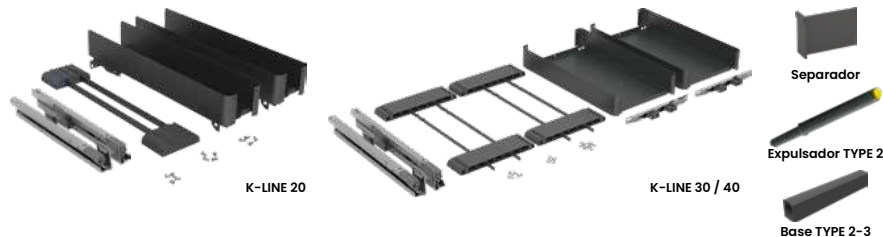

Instrucciones K-Line 200



Instrucciones K-Line 300/400





### NOVEDAD K-LINE PANERO

Código	Descripción	Ancho Módulo	Alto	Acabado	Embalaje
0505402	K-Line Panero	300	523	Antracita	1
0505502	K-Line Panero	400	523	Antracita	1
0503302	Separador Extraíble K-Line	---	---	Antracita	1
0200502	Expulsador Type 2	---	---	Antracita	1
0200402	Base Type 2-3	---	---	Antracita	1



### K-LINE BASE (suplemento H80) NOVEDAD

Código	Descripción	Ancho	Alto	Acabado	Embalaje
0505302	Suplemento K-Line base	150	190	Antracita	1

Este suplemento es válido, para combinar con toda la línea K-Line Base. Anchos de 20, 30 y 40 y para K-Line Panero de 30 y 40.

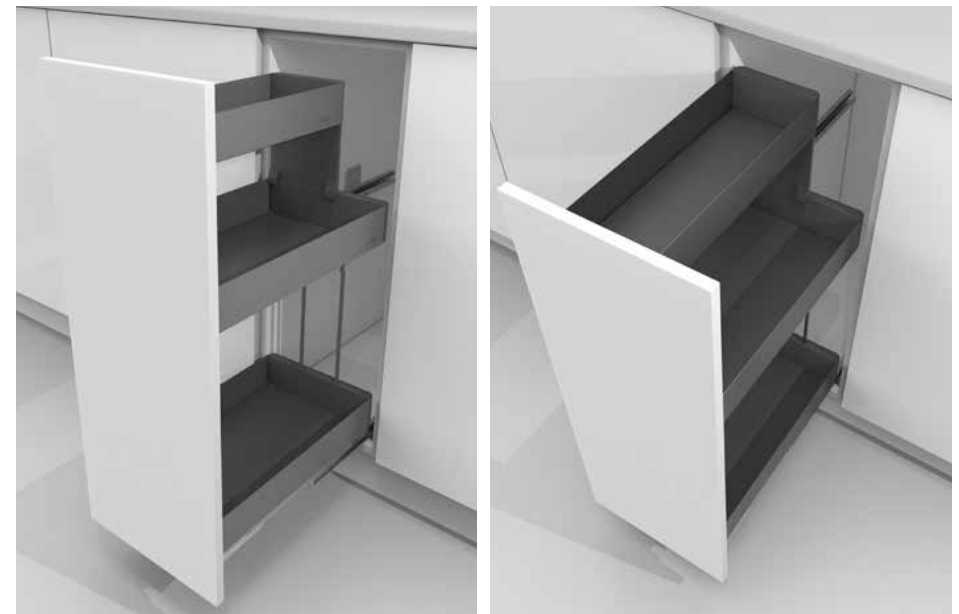
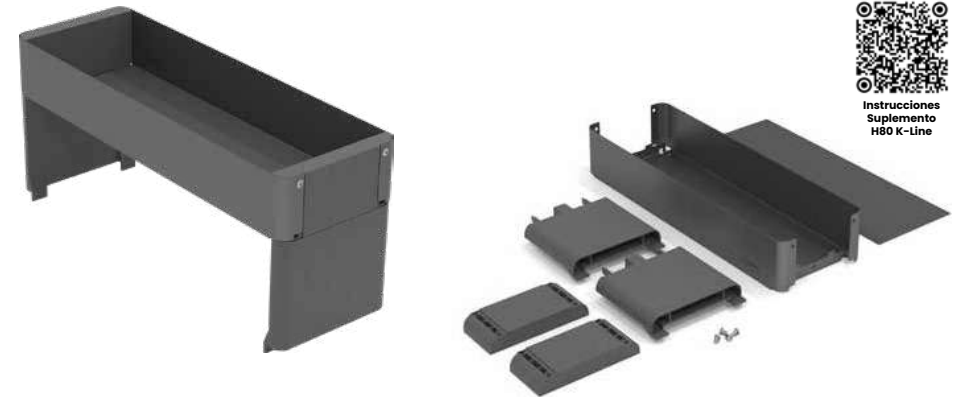



## COOKING AGENT ANTRACITA

NOVEDAD  
Ulabgroup



Código	Descripción	Ancho Módulo	Alto	Acabado	Embalaje
0503402	Cooking Agent	300	625	Antracita	1
0200602	Expulsador Type 3	---	---	Antracita	1
0200402	Base Type 2-3	---	---	Antracita	1

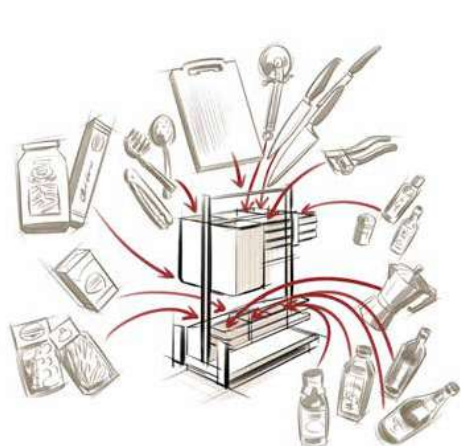

## CLEANING AGENT ANTRACITA

NOVEDAD  
Ulabgroup



Código	Descripción	Ancho	Alto	Acabado	Embalaje
0503502	Cleaning Agent	298	480	Antracita	1





# K-LINE SIDE

Limpeza & orden





## K-LINE SIDE NOVEDAD

NOVEDAD



Set de guías

Estante

Estante con barandilla



Riel de soporte con 4 ganchos

Listón 5 ganchos

Portarrollos de papel



Portarrollos Rollinero con borde corte

Cesta portatil limpieza

Riel de soporte con contenedor



Riel de soporte con 2 contenedores

Listón para atornillar lateralmente

Listón para montaje en techo

Código	Descripción	Ancho	Alto	Fondo	Longitud	Acabado	Embalaje
0503602	Set de guías	---	---	---	1073	Antracita	1
0503702	Estante	350	65	110	---	Antracita	1
0503802	Estante con barandilla	350	65	110	---	Antracita	1
0503902	Riel de soporte con 4 ganchos	350	60	45	---	Antracita	1
0504002	Listón 5 ganchos	350	50	32	---	Antracita	1
0504102	Portarrollos de papel	350	65	120	---	Antracita	1
0504202	Portarrollos Rollinero con borde corte	350	70	145	---	Antracita	1
0504302	Cesta portatil limpieza	442	315	160	---	Antracita	1
0504402	Riel de soporte con contenedor	350	138	95	---	Antracita	1
0504502	Riel de soporte con 2 contenedores	440	116	95	---	Antracita	1
0504602	Listón para atornillar lateralmente	350	---	---	---	Antracita	1
0504702	Listón para montaje en techo	350	---	---	---	Antracita	1
0504802	Soporte manguera de aspirador	150	70	63	---	Antracita	1
0504902	Contenedor de utensilios	255	300	140	---	Antracita	1
0505002	Set de almacenamiento cajas bebida	557	95	355	---	Antracita	1
0505102	Set de bandejas para cestas de ropa	---	---	---	---	Antracita	1
0505202	Soporte tabla de planchar o escalera	---	---	---	---	Antracita	1

**i** Todos los artículos cuya descripción aparece en color **negro**, serán para combinar con el set de guías, siendo los descritos en color **verde** de libre instalación.



Soporte manguera de aspirador

Contenedor de utensilios

Set de almacenamiento cajas bebida



Set de bandejas para cestas de ropa

Soporte tabla de planchar o escalera



KESSEBÖHMER

LeMans II ofrece hasta un

70%

más de superficie de almacenamiento  
comparado con un mueble de cajones  
extraíbles.



**LEMANS II**  
Confort fascinante





KESSELMANN



Instrucciones LeMans II



Instrucciones LeMans II (Fondos especiales)



LeMans II

Ejemplo. Apertura a izquierdas



## LEMANS II



Código	Descripción	Ancho Puerta	Alto	Acabado	Embalaje
0413620	Set 2 Bandejas Derecha	400	---	Classic/Cromo/Gris	1
0413720	Set 2 Bandejas Izquierda	400	---	Classic/Cromo/Gris	1
0422720	Set 2 Bandejas Derecha	450	---	Classic/Cromo/Gris	1
0422820	Set 2 Bandejas Izquierda	450	---	Classic/Cromo/Gris	1
0422920	Set 2 Bandejas Derecha	500	---	Classic/Cromo/Gris	1
0423020	Set 2 Bandejas Izquierda	500	---	Classic/Cromo/Gris	1
0423120	Set 2 Bandejas Derecha	600	---	Classic/Cromo/Gris	1
0423220	Set 2 Bandejas Izquierda	600	---	Classic/Cromo/Gris	1
0422001	Set 2 Bandejas Derecha	450	---	Style/Cromo/Blanco	1
0422101	Set 2 Bandejas Izquierda	450	---	Style/Cromo/Blanco	1
0422201	Set 2 Bandejas Derecha	500	---	Style/Cromo/Blanco	1
0422301	Set 2 Bandejas Izquierda	500	---	Style/Cromo/Blanco	1
0422401	Set 2 Bandejas Derecha	600	---	Style/Cromo/Blanco	1
0422501	Set 2 Bandejas Izquierda	600	---	Style/Cromo/Blanco	1
0426187	Set 2 Bandejas Derecha	450	---	Style/Silver/Blanco	1
0426287	Set 2 Bandejas Izquierda	450	---	Style/Silver/Blanco	1
0426387	Set 2 Bandejas Derecha	500	---	Style/Silver/Blanco	1
0426487	Set 2 Bandejas Izquierda	500	---	Style/Silver/Blanco	1
0426587	Set 2 Bandejas Derecha	600	---	Style/Silver/Blanco	1
0426687	Set 2 Bandejas Izquierda	600	---	Style/Silver/Blanco	1
0423320	Eje	---	600 - 750	Gris	1
0423420	Eje	---	720 - 900	Gris	1
0423520	Eje	---	≥1250	Gris	1
0422601	Eje	---	600 - 750	Blanco	1
0422701	Eje	---	720 - 900	Blanco	1
0422801	Eje	---	≥1250	Blanco	1
0413420	Freno Derecha (1 Ud.)	---	---	Gris	2
0413520	Freno Izquierda (1 Ud.)	---	---	Gris	2
0431201	Freno Derecha (1 Ud.)	---	---	Blanco	2
0431301	Freno Izquierda (1 Ud.)	---	---	Blanco	2



LeMans II  
Classic Cromo / Gris



LeMans II  
Style Cromo / Blanco



LeMans II  
Style Silver / Gris



## MAGIC CORNER

Código	Descripción	Ancho Módulo	Ancho Puerta Mínima	Alto	Acabado	Embalaje
0423620	Bastidor Derecha	900	---	525	Gris	1
0423720	Bastidor Izquierda	900	---	525	Gris	1
0423891	Set 4 Bandejas	---	450	---	Classic/Cromo/Gris	1
0422991	Set 4 Bandejas	---	450	---	Style/Cromo/Blanco	1

**i** Bandejas regulables en altura que posibilita un mayor aprovechamiento del espacio interior del módulo.



## REVO 90°

Código	Descripción	Alto	Acabado	Embalaje
0423920	Set Eje Revo 90°	660 - 860	Gris	1
0424020	Set 2 Bandejas Ø 81	---	Classic/Cromo/Gris	1
0424001	Set 2 Bandejas Ø 81	---	Style/Cromo/Blanco	1

**i** Para la fabricación de este mueble e instalación de este producto se recomienda previamente consultar con nuestro Dpto. Comercial. Posibilidad de regular la tensión del freno en el fin del recorrido. Sistema para rinconera angular de puertas escamoteables. Permite la regulación de la velocidad de posicionamiento del herraje. Bandejas regulables en altura. Capacidad de carga por bandeja 25 Kg.





## TORNO GIRATORIO 3/4

Código	Descripción	Alto	Acabado	Embalaje
0424220	Set 2 Bandejas Ø 70 + Eje	630 - 680	Classic/Cromo/Gris	1
0424320	Set 2 Bandejas Ø 82 + Eje	630 - 680	Classic/Cromo/Gris	1
0424101	Set 2 Bandejas Ø 70 + Eje	630 - 680	Style/Cromo/Blanco	1
0424201	Set 2 bandejas Ø 82 + Eje	630 - 680	Style/Cromo/Blanco	1
0450791	Eje	685 - 735	Cromo	1
0450891	Eje	742 - 832	Cromo	1
0450991	Eje	839 - 889	Cromo	1

**i** Válido para diferentes alturas de mueble en función del eje que se instale. Estos ejes pueden ser adaptados a medidas inferiores en altura, realizando un corte en la parte superior de dicho eje.  
Bandejas independientes regulables en altura que permiten un mejor aprovechamiento del espacio interior.  
Capacidad de carga por bandeja 25 Kg.



## MEDIA LUNA

Código	Descripción	Ancho Puerta	Alto	Acabado	Embalaje
0424120	Set 2 Bandejas + Eje	450	627	Classic/Cromo/Gris	1

**i** Reversible.  
Este accesorio irá fijado a una tabica interior, lo que nos posibilita la no utilización de bisagras especiales.  
Capacidad de carga por bandeja 20 Kg.  
Medida de altura de eje única.





KESSEBOHMER



Instrucciones Tandem



## TANDEM



Código	Descripción	Ancho Módulo	Alto	Acabado	Embalaje
0422220	Set Tandem	450	1700	Classic/Cromo/Gris	1
0422620	Set Tandem	600	1700	Classic/Cromo/Gris	1
0421501	Set Tandem	450	1700	Style/Cromo/Blanco	1
0421901	Set Tandem	600	1700	Style/Cromo/Blanco	1

**i** Reversible.

Balda tradicional

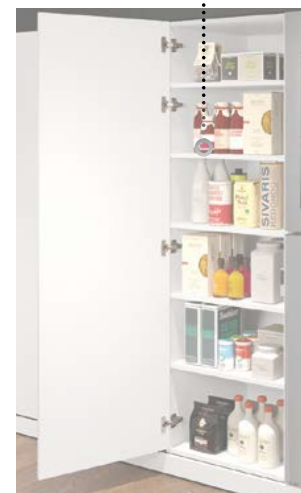

TANDEM  
100% Accesible y a la vista



Elemento extraíble

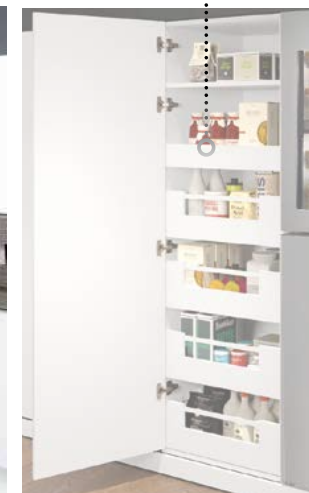



KESSEBÖHMER



Instrucciones  
Convoy Lavido



## CONVOY LAVIDO



Código	Descripción	Ancho Módulo	Alto Módulo	Acabado	Embalaje
0420201	Perfil	---	1800 - 2000	Blanco	1
0420301	Perfil	---	2000 - 2200	Blanco	1
0420701	Set 5 Bandejas	450	---	Vario/Cristal/Blanco	1
0420801	Set 5 Bandejas	600	---	Vario/Cristal/Blanco	1
0420901	Guía Convoy Lavido	---	---	Blanco	1





KESSEBÖHMER



## DISPENSA90

La solución perfecta para columnas de 30 y 40.

A la hora de equipar una columna de ancho 30 y 40, Dispensa es sin duda, la mejor solución. Allí donde implementar cajones, dejaría el mueble sin espacio para poder almacenar nada, Dispensa se presenta como una alternativa óptima.

Además, Dispensa, puede complementarse con todos los accesorios Youboxx para poder jugar con distintas configuraciones, así como con el eTouch + electrónico, si queremos un frente de columna push.





## DISPENSA 90



Código	Descripción	Ancho Módulo	Alto Módulo	Acabado	Embalaje
0420220	Estructura + Fijaciones	300	1200 - 1600	Gris	1
0420320	Estructura + Fijaciones	400	1200 - 1600	Gris	1
0420620	Estructura + Fijaciones	300	1600 - 2000	Gris	1
0420720	Estructura + Fijaciones	400	1600 - 2000	Gris	1
0421020	Estructura + Fijaciones	300	1900 - 2300	Gris	1
0421120	Estructura + Fijaciones	400	1900 - 2300	Gris	1
0413320	Juego Soporte Cestas	---	---	Gris	1
0460391	Pletina Unión Frente	---	---	Gris	1
0421520	Guía Dispensa 90 - 100 kg. PRO	---	---	Gris	1
0510120	eTOUCH+ Electrónico	---	---	Gris	1
0450191	Bandeja	300	---	Varilla/Cromo	1
0450291	Bandeja	400	---	Varilla/Cromo	1
0421720	Set Juego 2 Bandejas	300	---	Classic/Cromo/Gris	1
0421820	Set Juego 2 Bandejas	400	---	Classic/Cromo/Gris	1
0421001	Set Juego 2 Bandejas	300	---	Style/Cromo/Blanco	1
0421101	Set Juego 2 Bandejas	400	---	Style/Cromo/Blanco	1
0431701	Set 3 Youboxx	---	---	Blanco/Gris	1
0431801	Set 5 Youboxx	---	---	Blanco/Gris	1

**i** La Dispensa 90° admite instalación solo con cestas o con cestas y Set Youboxx.  
Las cestas de la Dispensa 90° son las mismas que las de Dispensa junior III.  
Capacidad de carga de la guía 100 Kg.

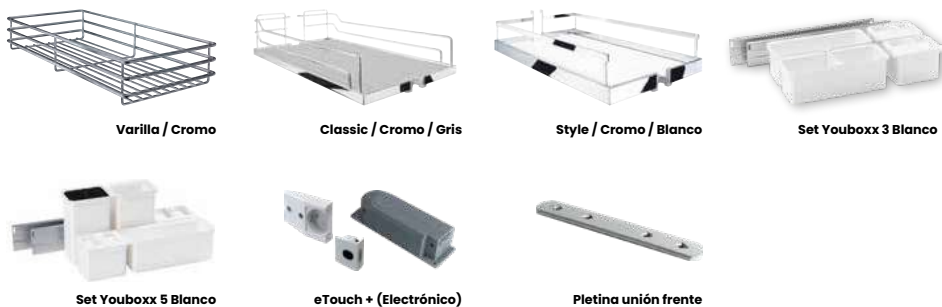

## DISPENSA junior III



Código	Descripción	Ancho Módulo	Alto	Acabado	Embalaje
0414320	Bastidor Dispensa Junior III	300	631	Gris	1
0414420	Bastidor Dispensa Junior III	400	631	Gris	1
0414620	Bastidor Dispensa Junior III	500	631	Gris	1
0414720	Bastidor Dispensa Junior III	600	631	Gris	1
0450191	Bandeja	300	---	Varilla/Cromo	1
0450291	Bandeja	400	---	Varilla/Cromo	1
0421720	Set Juego 2 Bandejas	300	---	Classic/Cromo/Gris	1
0421820	Set Juego 2 Bandejas	400	---	Classic/Cromo/Gris	1
0421920	Set Juego 2 Bandejas	500	---	Classic/Cromo/Gris	1
0422020	Set Juego 2 Bandejas	600	---	Classic/Cromo/Gris	1
0421001	Set Juego 2 Bandejas	300	---	Style/Cromo/Blanco	1
0421101	Set Juego 2 Bandejas	400	---	Style/Cromo/Blanco	1
0431601	Set 2 Youboxx	---	---	Blanco/Cromo	1
0431701	Set 3 Youboxx	---	---	Blanco/Gris	1
0431801	Set 5 Youboxx	---	---	Blanco/Gris	1





## EXTRAÍBLES 15 cms



Código	Descripción	Ancho Módulo	Alto	Acabado	Embalaje
0451091	Extraíble 2 pisos	150	540	Classic/Cromo	1
0426787	Extraíble 2 Pisos	150	540	Style/Silver	1
0451591	Extraíble 2 Pisos	150	540	Style/Cromo	1
0451391	Extraíble paños	150	540	Classic/Cromo	1
0460191	Extraíble 3 pisos	150	755	Classic/Cromo	1
0451491	Separador Classic	---	---	Cromo	1
0451991	Separador Style	---	---	Cromo	1
0426887	Separador Style	---	---	Silver	1
0288120	Expulsador Type 2	10	90	Gris	1
0115920	Base Type 2	---	107	Gris	1



## COMFORT II



Código	Descripción	Ancho Módulo	Alto	Acabado	Embalaje
0424420	Set 3 Bandejas	200	---	Classic/Cromo/Gris	1
0424520	Set 3 Bandejas	250	---	Classic/Cromo/Gris	1
0424620	Set 3 Bandejas	300	---	Classic/Cromo/Gris	1
0424720	Set 3 Bandejas	400	---	Classic/Cromo/Gris	1
0424801	Set 3 Bandejas	200	---	Style/Cromo/Blanco	1
0424901	Set 3 Bandejas	250	---	Style/Cromo/Blanco	1
0424301	Set 3 Bandejas	300	---	Style/Cromo/Blanco	1
0424401	Set 3 Bandejas	400	---	Style/Cromo/Blanco	1
0414120	Bastidor Comfort II Derecha	---	654	Gris	1
0414020	Bastidor Comfort II Izquierda	---	654	Gris	1
0288120	Expulsador Type 2	10	90	Gris	1
0115920	Base Type 2	---	107	Gris	1

**i** Este herraje se suministrará siempre en **Set de 3 Bandejas**. Imagen sólo orientativa para mostrar la estética del producto.







### PORTERO III



Código	Descripción	Ancho	Alto	Acabado	Embalaje
0499391	Portero III	276	510	Cromo/Translucido	1

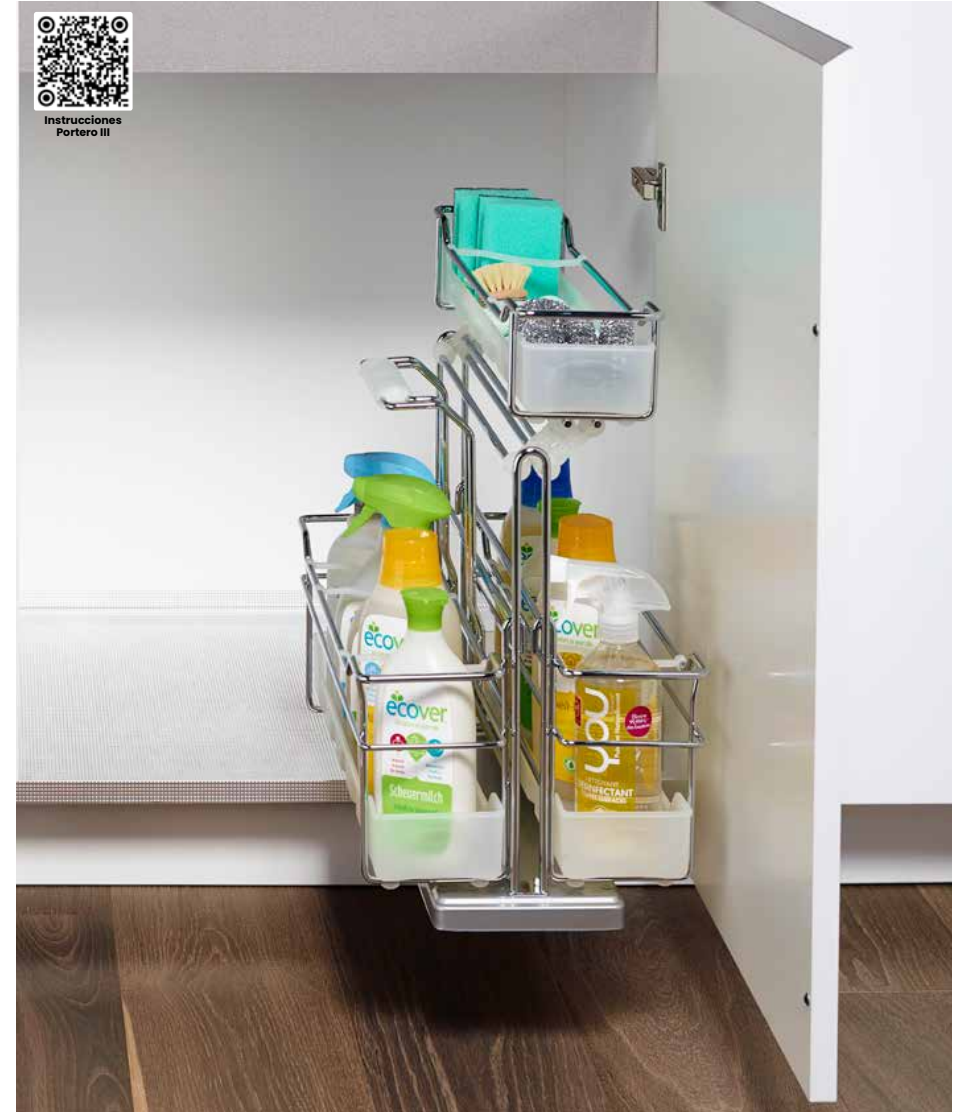

Instrucciones Portero III



INOXA



### SET COLUMNA CLEANING SYSTEM

Código	Descripción	Ancho Módulo	Alto	Fondo	Acabado	Embalaje
0453291	Set Columna Cleaning System 15 cms.	150	1720	450	Cromo	1

**i** Reversible.



INOXA



### ESTRUCTURA / CESTAS COLUMNA

Código	Descripción	Ancho Módulo	Ancho	Alto	Fondo	Acabado	Embalaje
0410120	Estructura Columna	300	250	1825/2185	500	Gris	1
0410220	Estructura Columna	400	350	1825/2185	500	Gris	1
0410320	Estructura Columna	450	400	1825/2185	500	Gris	1
0410420	Estructura Columna	600	550	1825/2185	500	Gris	1
0415620	Estructura Columna	300	250	1480/1860	500	Gris	1
0410520	Estructura Columna	300	250	1135/1495	500	Gris	1
0410620	Estructura Columna	400	350	1135/1495	500	Gris	1
0569491	Cesta Columna	300	230	120	420	Cromo	2
0569591	Cesta Columna	400	330	120	420	Cromo	2
0569691	Cesta Columna	450	380	120	420	Cromo	2
0569791	Cesta Columna	600	530	120	420	Cromo	2
0416020	Fijación Extra	300	250	---	---	Gris	1
0416120	Fijación Extra	400	350	---	---	Gris	1
0416220	Fijación Extra	450	400	---	---	Gris	1
0416320	Fijación Extra	600	550	---	---	Gris	1

**i** Capacidad de carga de la guía 110 Kg.





INOXA



### EXTRAÍBLE 15 cms

Código	Descripción	Ancho Módulo	Ancho	Alto	Fondo	Acabado	Embalaje
0415091	Minibotellero	150	110	520	280	Cromo	1
0415191	Minibotellero	150	110	520	500	Cromo	1
0415291	Minibotellero	200	160	520	500	Cromo	1
0415391	Minibotellero	250	210	520	500	Cromo	1
0419920	Separador Botellas	---	---	---	---	Gris	4

Estos artículos van equipados con guía V6 Hettich



Ficha técnica Extraíble 15 cms

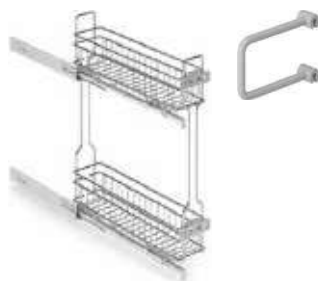

INOXA



### EXTRAÍBLE 2 CESTAS / 3 CESTAS

Código	Descripción	Ancho Módulo	Ancho	Alto	Fondo	Acabado	Embalaje
0420191	Extraíble Bot. 2 Cestas	300	264	500	500	Cromo	1
0420291	Extraíble Bot. 2 Cestas	400	364	500	500	Cromo	1
0414491	Extraíble 3 Cestas	300	264	500	500	Cromo	1
0414591	Extraíble 3 Cestas	350	314	500	500	Cromo	1
0414691	Extraíble 3 Cestas	400	364	500	500	Cromo	1
0414791	Extraíble 3 Cestas	450	414	500	500	Cromo	1

Estos artículos van equipados con guía V6 Hettich

### EXTRAÍBLE BOTELLERO PANERO

Código	Descripción	Ancho Módulo	Ancho	Alto	Fondo	Acabado	Embalaje
0410491	Extraíble Botellero Panero	300	264	500	450	Cromo	1
0410591	Extraíble Botellero Panero	350	314	500	450	Cromo	1
0410691	Extraíble Botellero Panero	400	364	500	450	Cromo	1
0410791	Extraíble Botellero Panero	450	414	500	450	Cromo	1

Estos artículos van equipados con guía V6 Hettich



Ficha técnica Extraíble 2 cestas



Ficha técnica Extraíble 3 cestas



Ficha técnica Botellero panero



INOXA



## CESTOS MULTIUSOS

Código	Descripción	Ancho Módulo.	Ancho	Alto	Fondo	Acabado	Embalaje
0413091	Cesto Multiusos	300	264	170	450	Cromo	1
0413191	Cesto Multiusos	350	314	170	450	Cromo	1
0413291	Cesto Multiusos	400	364	170	450	Cromo	1
0413391	Cesto Multiusos	450	414	170	450	Cromo	1
0413491	Cesto Multiusos	500	464	170	450	Cromo	1
0413591	Cesto Multiusos	600	564	170	450	Cromo	1

Estos artículos van equipados con guía V6 **Hettich**. El cesto multiusos incluye distanciador para instalar en el costado del mueble coincidente con las bisagras. Para conseguir una extracción perfecta.



INOXA



## SALVASIFÓN EXTRAÍBLE

Código	Descripción	Ancho Módulo	Ancho	Alto	Fondo	Acabado	Embalaje
0415691	Salvasifón extraíble	600	564	120	450	Cromo	1
0415791	Salvasifón extraíble	800	764	120	450	Cromo	1
0415891	Salvasifón extraíble	900	864	120	450	Cromo	1

Estos artículos van equipados con guía V6 **Hettich**



## ESCURREPLATOS EXTRAÍBLE

Código	Descripción	Ancho Módulo	Ancho	Alto	Fondo	Acabado	Embalaje
0411991	Escurreplatos extraíble	600	564	140	500	Cromo	1

Estos artículos van equipados con guía V6 **Hettich**





INOXA



## DINAMIC CORNER

Código	Descripción	Ancho Módulo	Ancho Puerta Mínima	H Min.-Máx.	Fondo	Acabado	Embalaje
0414191	Dinamic Corner Derecha	900	450	600 / 850	480	Cromo	1
0414291	Dinamic Corner Izquierda	900	450	600 / 850	480	Cromo	1



## GIREVOLE



Código	Descripción	Ancho Módulo	Alto	Diámetro	Acabado	Embalaje
0416991	Girevole 800	800 x 800	630 - 680	705	Cromo	1
0417091	Girevole 900	900 x 900	630 - 680	820	Cromo	1
0462091	Eje Girevole	---	820 - 830	---	Cromo	1

**i** El Giratorio 270° se entrega de serie con el eje de altura 630-680, el eje de altura 820-830 se suministrará como referencia independiente, pudiéndose adaptar mediante corte a medidas inferiores.  
Bandejas regulables en altura y sistema de fin de giro.



KAUTÄT



## HIDDEN CORNER

Código	Descripción	Ancho Puerta Mínima	Ancho Módulo Min.	Alto	Fondo	Acabado	Embalaje
0417591	Hidden Corner	400	800	580	500	Cromo	1

**i** Reversible.  
Válido para puerta de 400 mm. Para instalar con puerta de 400 mm, es necesario mecanizar el eje de la bisagra a 90 mm. de altura.





Instrucciones  
Compact Hyper



**COMPACT HYPER**

Código	Descripción	Ancho Puerta Mínima	Ancho Módulo Min.	Alto	Fondo	Acabado	Embalaje
0500102	Compact Hyper	400	740	560	480	Antracita	1
0500202	Compact Hyper	450	810	560	480	Antracita	1
0500302	Compact Hyper	500	840	560	480	Antracita	1
0500402	Compact Hyper	600	940	560	480	Antracita	1

**i** Reversible





INOXA



### MINIBOTELLERO

Código	Descripción	Ancho Módulo	Ancho	Alto	Fondo	Acabado	Embalaje
0401791	Minibotellero	150	110	520	500	Cromo	1
0401891	Minibotellero	200	160	520	500	Cromo	1
0419920	Separador Botellas	---	---	---	---	Gris	4

Estos artículos van equipados con guía optimizada **SALICE** (extracción 90%).



Ficha técnica Minibotellero

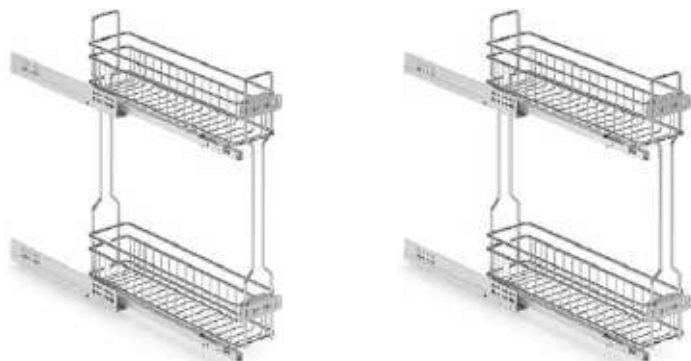

### BOTELLERO PANERO

Código	Descripción	Ancho Módulo	Ancho	Alto	Fondo	Acabado	Embalaje
0417691	Botellero Panero	300	264	500	500	Cromo	1
0417791	Botellero Panero	400	364	500	500	Cromo	1

Estos artículos van equipados con guía optimizada **SALICE** (extracción 90%).



Ficha técnica Botellero panero

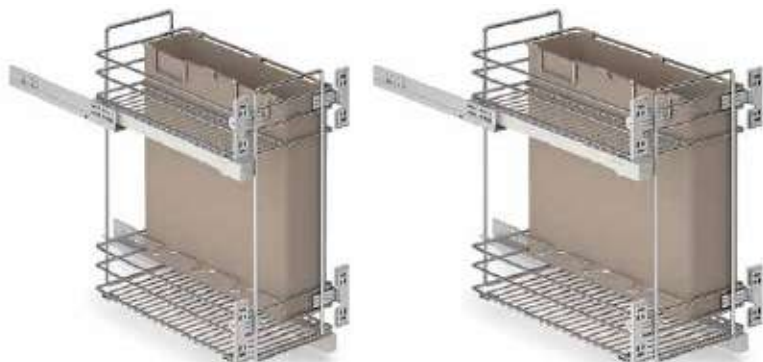

INOXA



### BOTELLERO 2 CESTAS

Código	Descripción	Ancho Módulo	Ancho	Alto	Fondo	Acabado	Embalaje
0452691	Botellero 2 Cestas	300	264	500	500	Cromo	1
0452791	Botellero 2 Cestas	400	364	500	500	Cromo	1

Estos artículos van equipados con guía optimizada **SALICE** (extracción 90%).



Ficha técnica Botellero 2 cestas





**EXTRAÍBLE MINIBOTELLERO (Altura 800)**

Código	Descripción	Ancho Módulo	Alto	Fondo	Acabado	Embalaje
0404507	Extraíble Minibotellero	150	690	456	Antracita	1
0404607	Extraíble Minibotellero	200	690	456	Antracita	1
0404707	Extraíble Minibotellero	250	690	456	Antracita	1

Estos artículos van equipados con guía XP extracción total **GRASS**

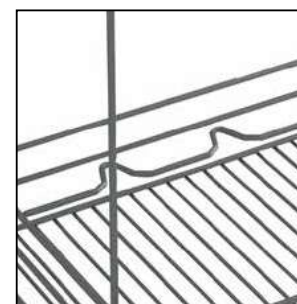

Varilla Antracita

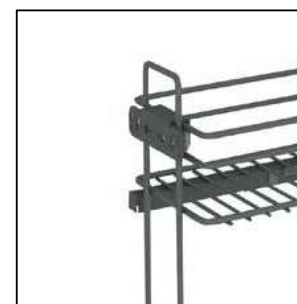

Embellecedor metálico de la guía



Serie equipada con guía **GRASS**



Ficha técnica Minibotellero

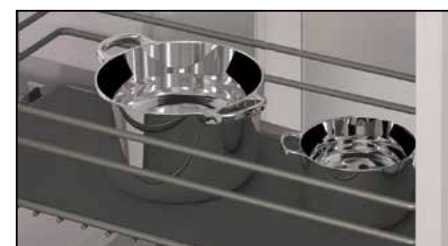

Gran capacidad de almacenaje



Regulación tridimensional







**EXTRAÍBLE BOTELLERO 3 CESTAS** (Altura 800)



Código	Descripción	Ancho Módulo	Alto	Fondo	Acabado	Embalaje
0405107	Extraíble Botellero 3 Cestas	300	690	456	Antracita	1
0405207	Extraíble Botellero 3 Cestas	400	690	456	Antracita	1

**i** Estos artículos van equipados con guía XP extracción total **GRASS**



Ficha técnica  
Extraíble 3 cestas

**EXTRAÍBLE BOTELLERO - PANERO** (Altura 800)



Código	Descripción	Ancho Módulo	Alto	Fondo	Acabado	Embalaje
0405507	Extraíble Botellero Panero	300	690	456	Antracita	1
0405607	Extraíble Botellero Panero	400	690	456	Antracita	1

**i** Estos artículos van equipados con guía XP extracción total **GRASS**

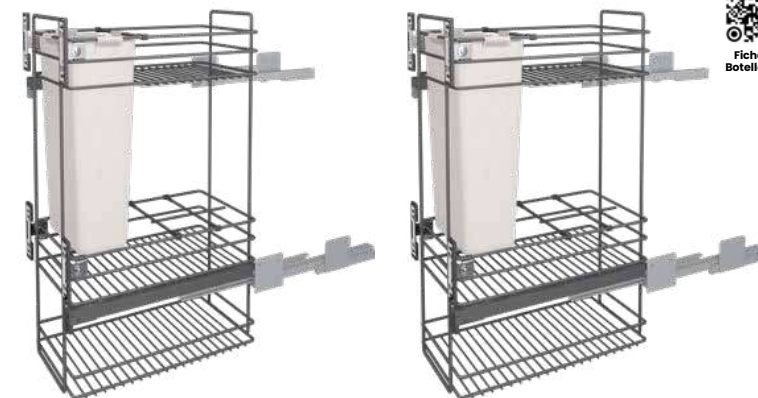

Ficha técnica  
Botellero Panero



KESSEBÖHMER



Instrucciones  
iMove



Manual de  
usuario iMove



## iMove



Código	Descripción	Ancho Módulo	Alto	Acabado	Embalaje
0414920	iMove Individual	600	380	Gris	1
0415120	iMove Individual	900	380	Gris	1
0415320	iMove Doble	600	565	Gris	1





INOXA



### ESCURREPLATOS 701

Código	Descripción	Ancho Módulo	Acabado	Embalaje
0400183	Set escurreplatos 701	450	Silver	25
0400283	Set escurreplatos 701	500	Silver	25
0400383	Set escurreplatos 701	600	Silver	25
0400483	Set escurreplatos 701	700	Silver	25
0400583	Set escurreplatos 701	800	Silver	25
0400683	Set escurreplatos 701	900	Silver	25
0400100	Bandeja vierteaguas metacrilato	450	Transparente	25
0400200	Bandeja vierteaguas metacrilato	500	Transparente	25
0400300	Bandeja vierteaguas metacrilato	600	Transparente	25
0400400	Bandeja vierteaguas metacrilato	700	Transparente	25
0400500	Bandeja vierteaguas metacrilato	800	Transparente	25
0400600	Bandeja vierteaguas metacrilato	900	Transparente	25
0400520	Regleta escurreplatos	---	Gris	1
0400620	Regleta escurreplatos / bandeja	---	Gris	1

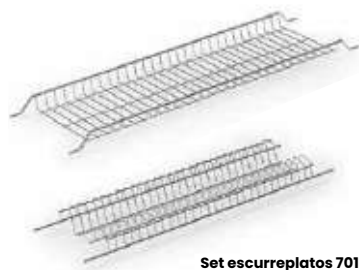

Set escurreplatos 701



Regleta escurreplatos

Regleta escurreplatos / bandeja



Bandeja vierteaguas metacrilato



INOXA



### ESCURREPLATOS 702

Código	Descripción	Ancho Módulo	Acabado	Embalaje
0400389	Escurreplatos 702	600	Acero Inox	10
0400489	Escurreplatos 702	700	Acero Inox	10
0400589	Escurreplatos 702	800	Acero Inox	10
0400689	Escurreplatos 702	900	Acero Inox	10
0400300	Bandeja vierteaguas metacrilato	600	Transparente	25
0400400	Bandeja vierteaguas metacrilato	700	Transparente	25
0400500	Bandeja vierteaguas metacrilato	800	Transparente	25
0400600	Bandeja vierteaguas metacrilato	900	Transparente	25
0400520	Regleta escurreplatos	---	Gris	1
0400620	Regleta escurreplatos / bandeja	---	Gris	1



Escurreplatos 702



Regleta escurreplatos

Regleta escurreplatos / bandeja



Bandeja vierteaguas metacrilato



## ESCURREPLATOS LAMINADO ACERO INOX



Código	Descripción	Ancho Módulo	Acabado	Embalaje
0502189	Jgo. Escurreplatos Laminado Acero Inox Bandeja Inox	400	Ínox / Gris	1
0502289	Jgo. Escurreplatos Laminado Acero Inox Bandeja Inox	450	Ínox / Gris	1
0502389	Jgo. Escurreplatos Laminado Acero Inox Bandeja Inox	500	Ínox / Gris	1
0502489	Jgo. Escurreplatos Laminado Acero Inox Bandeja Inox	600	Ínox / Gris	1
0502589	Jgo. Escurreplatos Laminado Acero Inox Bandeja Inox	700	Ínox / Gris	1
0502689	Jgo. Escurreplatos Laminado Acero Inox Bandeja Inox	800	Ínox / Gris	1
0502789	Jgo. Escurreplatos Laminado Acero Inox Bandeja Inox	900	Ínox / Gris	1
0502889	Jgo. Escurreplatos Laminado Acero Inox Bandeja Inox	1000	Ínox / Gris	1
0400800	Portacubiertos / Platos	---	Transparente	10
0400700	Portaplatos	---	Transparente	20





INOXA

## EQUIPAMIENTO DE MUEBLE

Código	Descripción	Ancho	Alto	Fondo	Acabado	Embalaje
0420391	Bastidor Despensor 4 Alturas	350	900	240	Cromo	1
0420691	Portadetergente Puerta	355	415	105	Cromo	1



KAUTÄT

## PORTACOPAS CROMO

Código	Descripción	Ancho	Alto	Fondo	Acabado	Embalaje
0502091	Portacopas Cromo	110	64	320	Cromo	20



## PORTACOPAS NEGRO MATE

Código	Descripción	Ancho	Alto	Fondo	Acabado	Embalaje
0503307	Portacopas Negro	480	32	250	Negro Mate	1





INOXA



### CESTA DE ROPA EXTRAÍBLE

Código	Descripción	Ancho Módulo	Ancho	Alto	Fondo	Acabado	Embalaje
0461591	Cesta Ropa Extraíble	300	262	550	470	Cromo	1
0461691	Cesta Ropa Extraíble	400	362	550	470	Cromo	1
0461791	Cesta Ropa Extraíble	450	412	550	470	Cromo	1
0461891	Cesta Ropa Extraíble	600	562	550	470	Cromo	1

Estos artículos van equipados con guía optimizada **SALICE** (extracción 90%).



### CESTA DE ROPA ABATIBLE



Código	Descripción	Ancho Módulo	Ancho	Alto	Fondo	Acabado	Embalaje
0416591	Cesta Ropa Abatible	400	350	400/500	270	Cromo	1
0416691	Cesta Ropa Abatible	450	400	400/500	270	Cromo	1
0416791	Cesta Ropa Abatible	500	450	400/500	270	Cromo	1
0416891	Cesta Ropa Abatible	600	550	400/500	270	Cromo	1



Ficha técnica  
Tolva abatible



### BASKET



Código	Descripción	Ancho Módulo	Ancho Tablero	Alto Min.	Fondo Min.	Acabado	Embalaje
0510301	Cesta Ropa Basket	600	555	690	450	Ínox / Beige	1

Este artículo se suministrará con tablero blanco soft 16 mm.



Instrucciones  
Basket

### LAVANDA



Código	Descripción	Ancho Módulo	Ancho	Alto	Fondo	Acabado	Embalaje
0510101	Cesta de ropa extraíble 35+35 L	600	562-568	570	506	Blanco / Azul	1



Instrucciones  
Lavanda



## TABLA DE PLANCHAR PRUA LIFT



Código	Descripción	Ancho Módulo	Ancho	Alto Min.	Fondo Min.	Acabado	Embalaje
0526287	Tabla Plancha Prua Lift	350	280	1100	100	Ínox/Gris	1



## TABLA DE PLANCHAR PRUA



Código	Descripción	Alto Min	Ancho Min	Fondo Min	Acabado	Embalaje
0601220	Tabla Plancha Prua	150	360	535	Ínox / Gris	1



## TABLA DE PLANCHAR ROTANTE



Código	Descripción	Ancho Min.	Alto Min.	Fondo Min.	Acabado	Embalaje
0510201	Tabla de planchar extraíble - giratoria	302	125	470	Gris	1

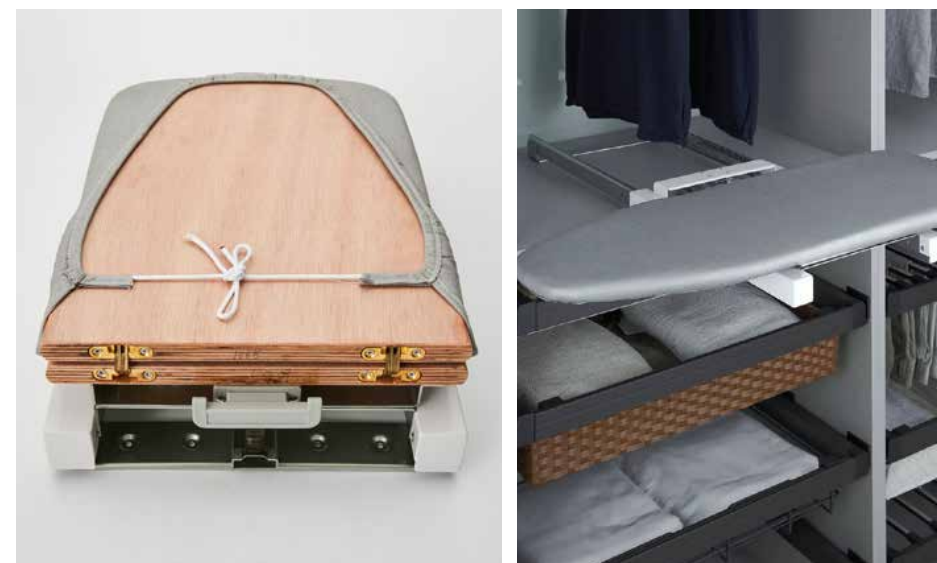



## ESCALERA ELEVA

130kg

Código	Descripción	Ancho	Alto	Grosor	Acabado	Embalaje
0526187	Eleva 2 peldaños	420	450	87	Aluminio / Antracita	1

